

SR 900-SISTEMA

VISIÓN GENERAL DEL SISTEMA

MEDIA MÁSCARA

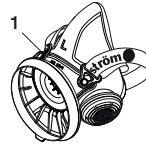

FILTRO

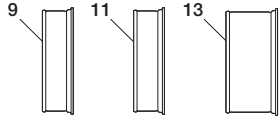

SOPORTE DE FILTRO REMOTO

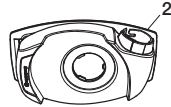

VENTILADOR

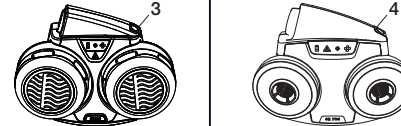

ACCESORIO DE AIRE COMPRIMIDO

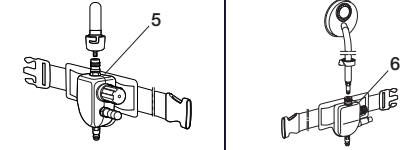

MANGUERA DE RESPIRACIÓN

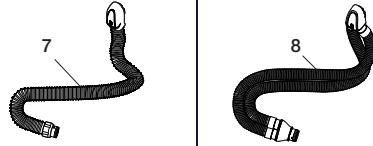

MANGUERA DE RESPIRACIÓN

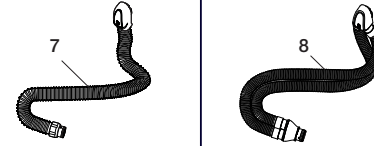

MANGUERA DE RESPIRACIÓN

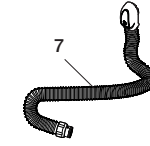

Núm.	Denominación	Designación	Núm de pedido
1.	Media máscara	SR 900 S SR 900 M SR 900 L	H01-3012 H01-3112 H01-3212
2.	SopORTE de filtro remoto	SR 905	T01-3002
3.	Ventilador	SR 500	H06-0112
4.	Ventilador	SR 700	H06-7010
5.	Accesorio de aire comprimido	SR 507	H03-0612
6.	Accesorio de aire comprimido	SR 307	H03-1412
7.	Manguera	SR 951	T01-3003
8.	Manguera doble	SR 952	R01-3009
9.	Filtro de partículas P3 R	SR 510	H02-1312
10.	Filtro de partículas P3 R	SR 710	H02-1512
11.	Filtro de gas A1 Filtro de gas A2 Filtro de gas AX Filtro de gas ABE1 Filtro de gas ABE2 Filtro de gas K1 Filtro de gas K2 Filtro de gas ABEK1	SR 217 SR 218 SR 298 SR 315 SR 294 SR 316 SR 295 SR 297	H02-2512 H02-2012 H02-2412 H02-3212 H02-3312 H02-4213 H02-4312 H02-5312
12.	Filtro de gas A2 Filtro de gas ABE1 Filtro de gas A1BE2K1	SR 518 SR 515 SR 597	H02-7012 H02-7112 H02-7212
13.	Filtro combinado ABEK1-Hg-P3 R	SR 299-2	H02-6512
14.	Filtro combinado A1BE2K1-Hg-P3 R	SR 599	H02-7312
15.	Manguera	SR 360	H03-34XX
16.	Manguera	SR 358	H03-30XX
17.	Manguera	SR 359	H03-31XX
18.	Filtro de aire comprimido	SR 99-1	H03-2810

FILTRO

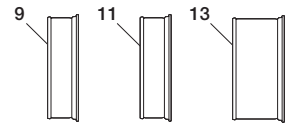

FILTRO

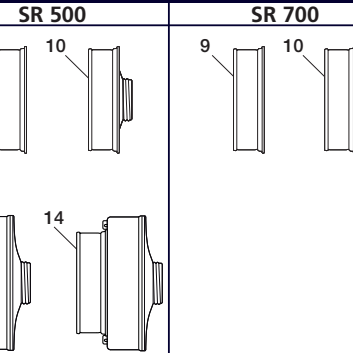

MANGUERA DE AIRE COMPRIMIDO

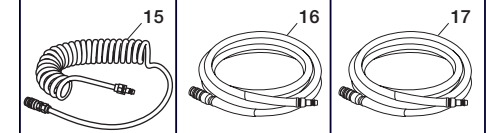

FILTRO DE AIRE COMPRIMIDO

